

SHT31N

Shunt Trip

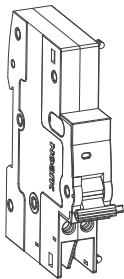

1

Installation Instructions

Notice d'installation

Instrucciones de montaje

NOARK

ZSHT31N201208NA

SHT31N



WARNING

2

DO NOT ATTEMPT TO INSTALL OR PERFORM MAINTENANCE ON EQUIPMENT WHILE IT IS ENERGIZED. DEATH, SEVERE PERSONAL INJURY, OR SUBSTANTIAL PROPERTY DAMAGE CAN RESULT FROM CONTACT WITH ENERGIZED EQUIPMENT. ALWAYS VERIFY THAT NO VOLTAGE IS PRESENT BEFORE PROCEEDING WITH THE TASK, AND ALWAYS FOLLOW GENERALLY ACCEPTED SAFETY PROCEDURES.

NOARK IS NOT LIABLE FOR THE MISAPPLICATION OR MISSINSTALLATION OF IT'S PRODUCTS.

SHT31N

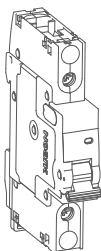

1

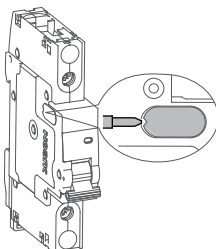

2

3

SHT31N

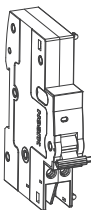



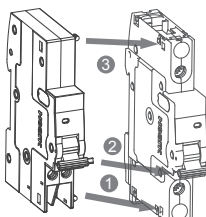

3



4

4

SHT31N

	 Z1
	18-14AWG (0.5-4mm ²)
	9lb.in(1.0Nm)

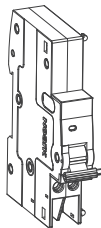

5

SHT31N

SHT31N

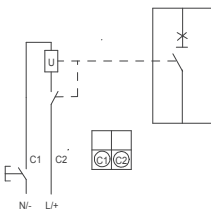
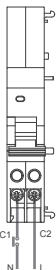

6

SHT31N

SHT3111N(1NO+1NC)

7

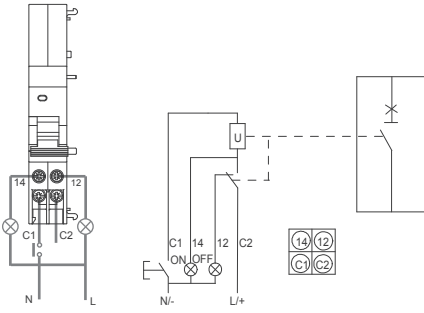

SHT31N

8

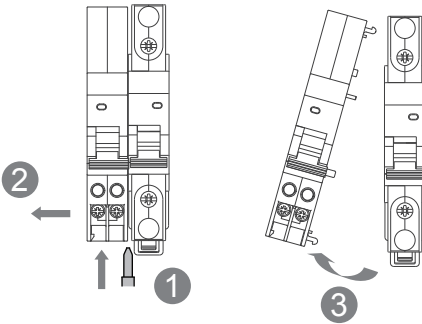

SHT31N

9

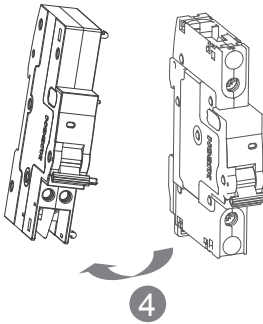

SHT31N

10

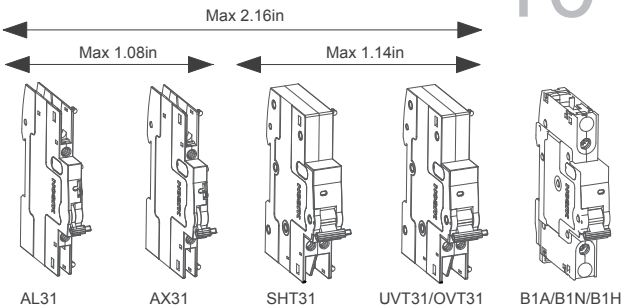

NOARK



Printed with environment-friendly paper

Copyright Noark. All Rights Reserved

www.noark-electric.com

08/2012