

MOD24N

Motor Mechanism

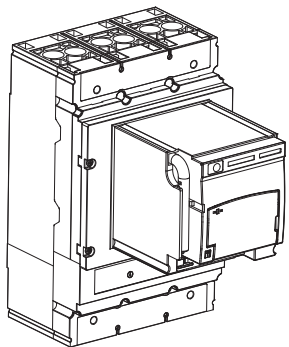

NOARK

A

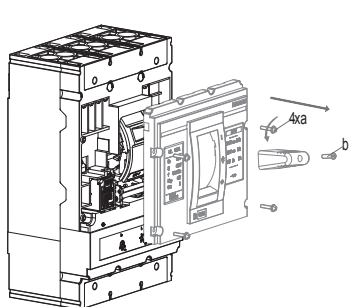

1

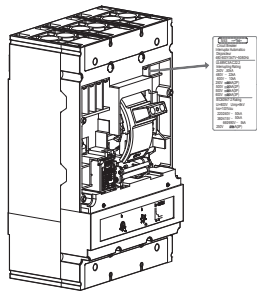
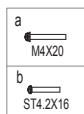

2

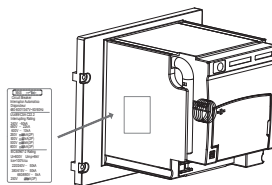

3

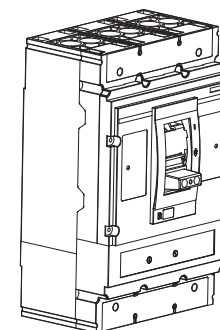
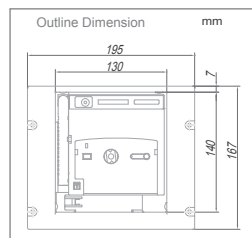

4

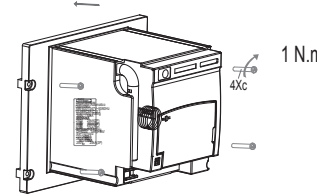
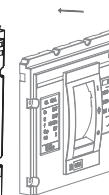

1 N.m

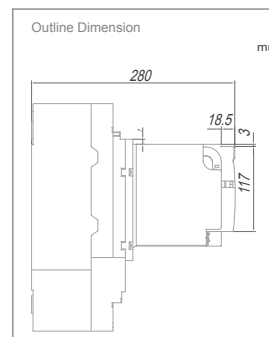

B

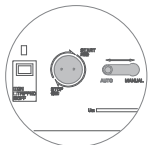
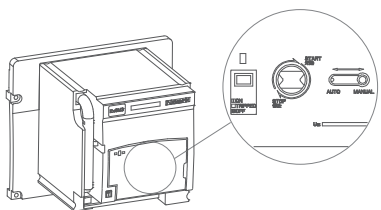

Motor-Operating

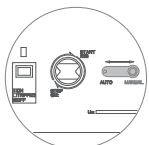

Hand-Operating

C

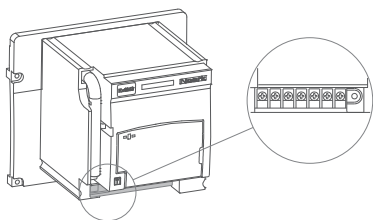

1

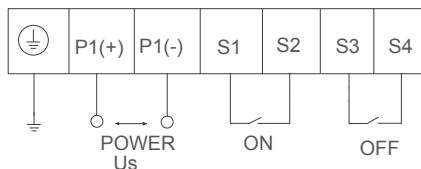

2

D

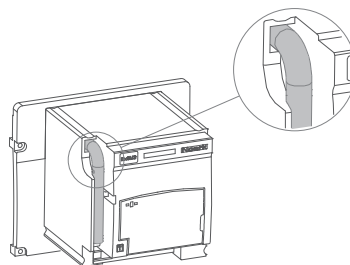

1

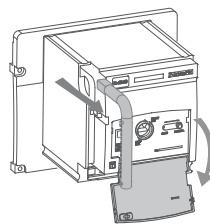

2

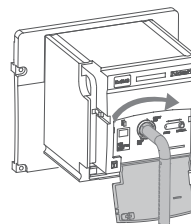

3

E

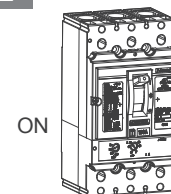

ON

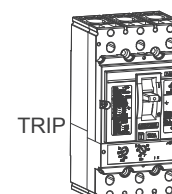

TRIP

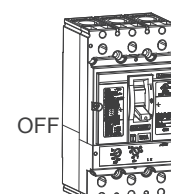

OFF

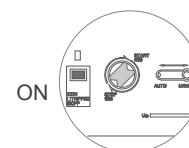

ON

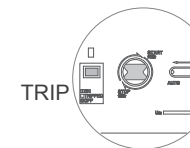

TRIP

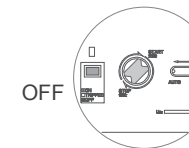

OFF

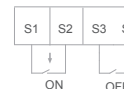

ON

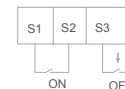

OFF

