

MOD23N

Motor Mechanism

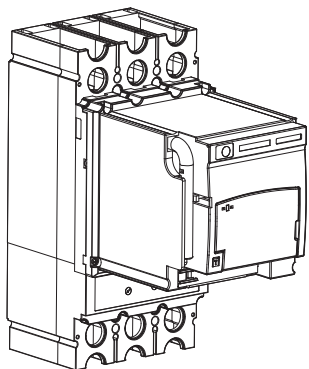

NOARK

A

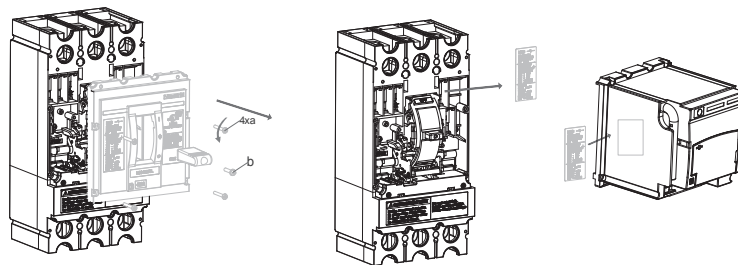

1

2

3

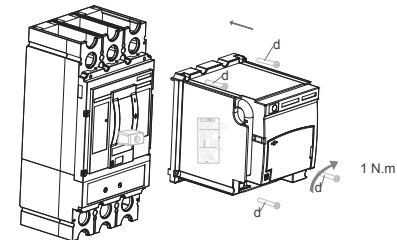

6



1 N.m

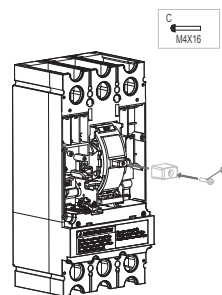

4

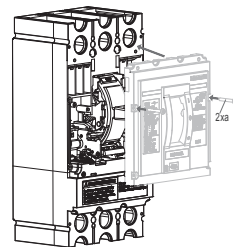

5

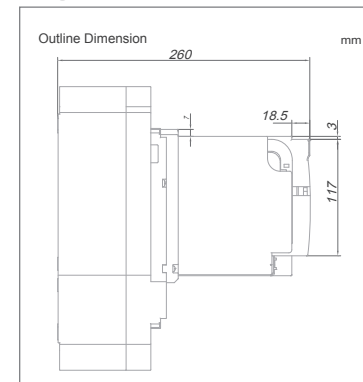
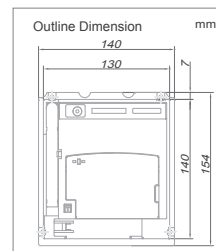

B

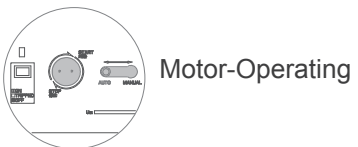
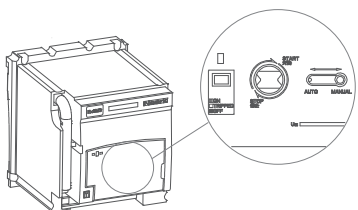

Motor-Operating

Hand-Operating

C

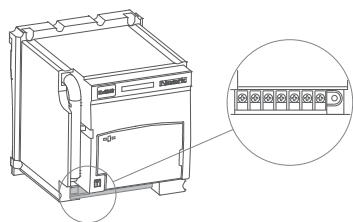

1

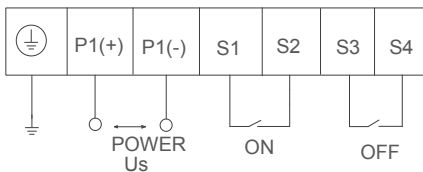

2

D

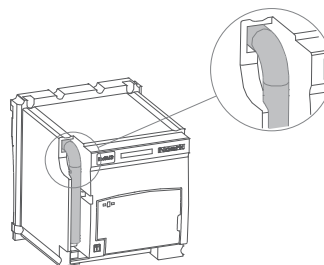

1

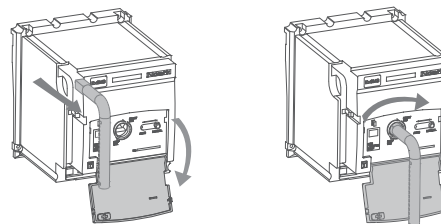

2

3

E

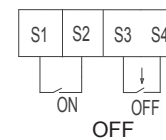
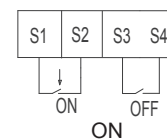
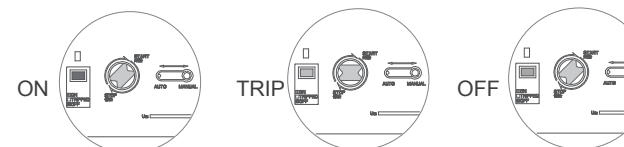
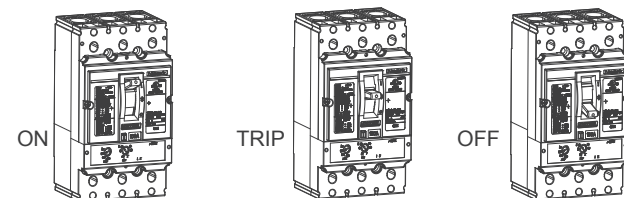

Printed with environment-friendly paper

Copyright Noark. All Rights Reserved

www.noark-electric.com

NOARK

ZMOD23N201404NA